THE 'L' SERIES OPERATORS HANDBOOK

HANDBOOK CONTENTS

	page
Introduction	2
Engine Features	3
1. General Information	4
2. Operating Instructions	7
3. Engine Fluids	11
4. Engine Servicing	13
5. Index	23

Introduction

Introduction

The purpose of this handbook is to lay down operating guidelines for the LT1 and LV1 engine ranges.

The specification details given apply to a range of engines and not to any one particular engine, in cases of difficulty the user should consult the local Lister Petter Distributor or Dealer for further advice and technical assistance.

The information, specifications, illustrations, instructions and statements contained within this publication are given with our best intentions and are believed to be correct at the time of going to press.

Our policy is one of continued development and we reserve the right to amend any technical information with or without prior notice.

Whilst every effort is made to ensure the accuracy of the particulars contained within this publication neither the Manufacturer, Distributor or Dealer shall in any circumstances be held liable for any inaccuracy or the consequences thereof.

The information given is subject to the Company's current Conditions of Tender and Sale, and is for the assistance of users and is based upon results obtained from tests carried out at the place of

manufacture. This Company does not guarantee that the same results will be obtained elsewhere under different conditions.

Using this Operators Handbook

It is recommended the individual steps contained in the various maintenance or repair operations are followed in the sequence in which they appear.

When a diesel engine is operating or being overhauled there are a number of associated practices which may lead to personal injury or product damage.

Your attention is drawn to the symbols shown and described below which are applied throughout this publication.

CAUTION

This caution symbol draws attention to special instructions or procedures which, if not correctly followed, may result in damage to or destruction of equipment.

WARNING

This warning symbol draws attention to special instructions or procedures which, if not strictly observed, may result in personal injury.

WARNING

A WARNING SYMBOL WITH THIS TYPE OF TEXT DRAWS ATTENTION TO SPECIAL INSTRUCTIONS OR PROCEDURES WHICH, IF NOT STRICTLY OBSERVED, MAY RESULT IN SEVERE PERSONAL INJURY, OR LOSS OF LIFE.

Running-in

A gradual running-in of a new engine is not necessary. Extended light load running early in the life of the engine may cause detrimental damage to the cylinder bore allowing lubricating oil to enter the exhaust system.

To help assist engine running-in, all engines are despatched with an initial fill lubricating oil which must be changed after 100 hours.

Associated Publications

Workshop Manual P027-09207
Master Parts Manual P027-08043
Technical Handbook P027-09212

Engine Features

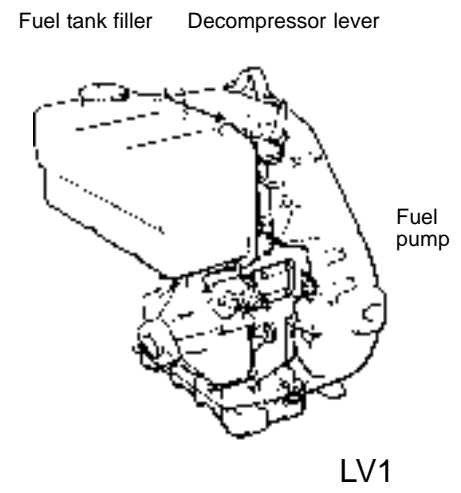
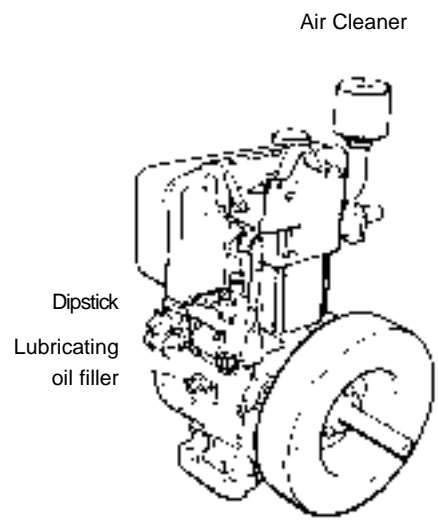
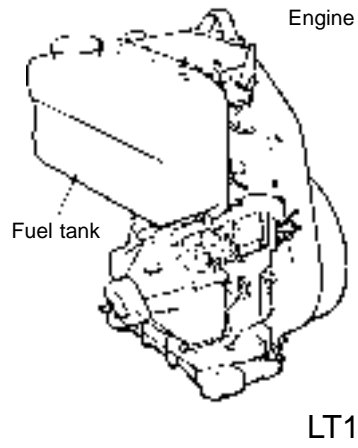

1. General Information

- safety precautions

1. General Information

1.1 Safety Precautions

The following safety precautions are of a general nature, more specific precautions appear where they are relevant.

1.1.1 General Precautions

- Ensure the engine is securely mounted.
- Ensure that there is a generous supply of cooling and combustion air available.
- Keep the engine and surrounding area clean.
- Keep all safety guards in position.
- Keep the body and clothing clear of all moving or hot parts.
- Never allow any part of the body to come into contact with high pressure fuel oil, for example when testing fuel injection equipment.
- Thoroughly clean any lubricating or fuel oil from the skin as soon as possible.
- Rectify all fuel, water and oil leaks as soon as practicable and clean any spillages when they occur.

1.1.2 Before Starting Precautions

WARNING

Starting any diesel engine can be dangerous in the hands of inexperienced people. Engine operators must be

instructed in the correct procedures before attempting to start any engine.

- Ensure the engine is free to turn without obstruction.
- Check that the lubricating oil level is correct.
- The oil sump must be filled to the 'full' mark on the dipstick; do not overfill.
- Check that the fuel supply is adequate and the system is primed.
- Ensure that the battery is connected, fully charged and serviceable.
- Where possible, disengage the driven equipment while starting.

1.1.3 Charge Winding Precautions

The following points must be strictly observed when charge windings are fitted otherwise serious damage can be done.

- Never remove any electrical cable while the battery is connected in the circuit.
- Only disconnect the battery with the engine stopped and all switches in the OFF position.
- Always ensure that cables are fitted to their correct terminals.
A short circuit or reversal of polarity will ruin diodes and transistors.

- Never connect a battery into the system without checking that the voltage and polarity are correct.
- Never flash any connection to check the current flow.
- Never experiment with any adjustments or repairs to the system.
- The battery and charge windings must be disconnected before commencing any electric welding when a pole strap is directly or indirectly connected to the engine.



WARNING

Starting engines that are fitted with charge windings which have been disconnected from the battery will cause irreparable damage unless the stator leads from the rectifier/regulator have been removed.

1.1.4 Starter Battery Precautions

- Do not smoke near the batteries.
- Keep sparks and flames away from the batteries.
- Batteries contain sulphuric acid - if the acid has been splashed on the skin, eyes or clothes flush it away with copious amounts of fresh water and seek medical aid.

- Keep the top of the battery well ventilated during charging.
- **Disconnect the battery negative (earth) lead first and reconnect last.**
- Switch off the battery charger before disconnecting the charger leads.
- Never 'flash' connections to check current flow.
- A damaged or unserviceable battery must never be used.

1.1.5 Lifting Precautions

The following points must be considered before attempting to lift the engine.

- Ensure the lifting equipment to be used has the correct capacity to lift the engine.
- A single engine lifting eye is fitted . Suitable lifting equipment designed to give a vertical lift from directly above the engine lifting eye must be used.
- Check that the engine lifting eye is not damaged and is secure.
- The lifting eye fitted to the engine is suitable for lifting the engine and accessory assemblies originally fitted by Lister Petter.

WARNING

Engine lifting eyes must not be used to lift the complete plant.

1.2 Safety Symbols

This section identifies the ISO 8999 symbols currently used by Lister Petter.

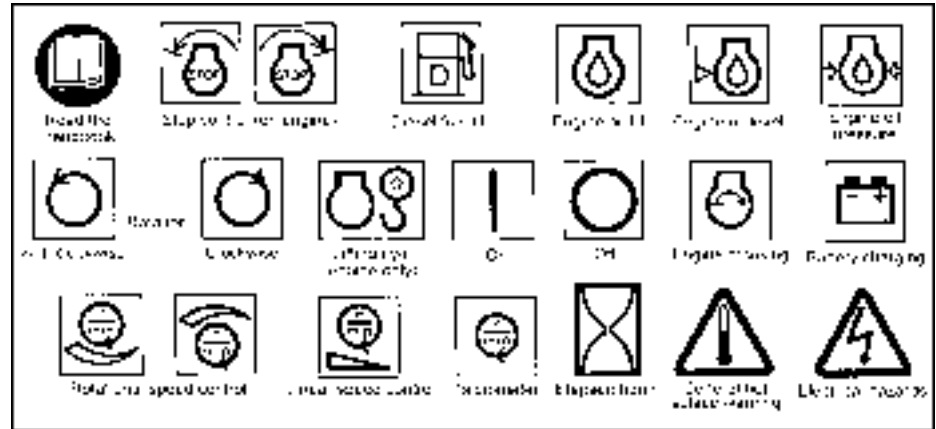

1. General Information

- technical data and engine identification

1.3 Technical Data

		LT1	LV1
Rotation ¹		Clock and anti-clock	Clock and anti-clock
Type of injection		Direct	Direct
Number of cylinders		1	1
Electrical system ²		12v negative earth	12v negative earth
Battery charging system ²		Charge windings	Charge windings
Oil pressure - minimum	bar	0.4	0.4
	lbf/in ²	5.8	5.8
Oil sump capacity	litres	1.3	1.3
	pints	2.3	2.3
	US qts	1.3	1.3
Capacity between dipstick marks	litres	0.2	0.2
	pints	0.35	0.35
	US qts	0.21	0.21
Fuel tank capacity	litres	5.0/8.25	8.25/13.5
	pints	8.8/14.5	14.5/23.7
	US qts	5.3/8.7	8.7/14.2

Notes:

1. Rotation is dependant on Build - refer to "1.5 Engine Serial Number".
2. Fitted as standard on some builds.

1.4 Nomenclature

LT1 - single cylinder, direct injection, naturally aspirated, flywheel fan air cooled diesel engine.

Build 32 is convection cooled.

LV1 - single cylinder, direct injection, naturally aspirated, flywheel fan air cooled diesel engine.

Build 32 is convection cooled.

1.5 Engine Serial Number

The engine serial number is stamped on a plate attached to the air shield on the manifold side of the engine. It is necessary to identify the type and build of each engine to enable the correct maintenance procedures, as described later in this publication, to be carried out.

Typical Serial Number

03 00123 LV1 C 01

Serial Number Code

03 Year code (03=2003)
00123 Consecutive number of engine
LV1 Model
A Anti-clockwise rotation
C Clockwise rotation
01 Build of engine

2. Operating Instructions

2.1 Preliminary Instructions

The following operating instructions are of a general nature and should be read in conjunction with, or substituted by, the equipment manufacturers instructions.

WARNING

Starting any diesel engine can be dangerous in the hands of inexperienced people. Before attempting to start any engine the operator should read the "1.1 Safety Precautions" and be conversant with the use of the engine controls and the correct starting procedures.

CAUTION

ETHER BASED COLD START AIDS IN AEROSOL CANS MUST NOT BE USED UNDER ANY CIRCUMSTANCES. Systems may be fitted to allow a measured quantity to be injected into the inlet manifold, but these must be used in accordance with the manufacturers instructions.

WARNING

EXHAUST GASES CONTAIN CARBON MONOXIDE WHICH IS A COLOURLESS, ODOURLESS AND POISONOUS GAS THAT CAN CAUSE UNCONSCIOUSNESS AND DEATH.

The engines are able to run satisfactorily at ambient temperatures up to 25°C (77°F) without derating. Above this temperature the rated power must be reduced in accordance with the relevant ISO, BS or DIN Standards.

The maximum temperature is 52°C (125°F) and if it is desired to run at higher temperatures the local Lister Petter Distributor or Dealer should be consulted.

2.2 Starting Handle Precautions

A non-limited kick-back handle (A), or limited kick-back handle (B) system may be fitted to the engine.

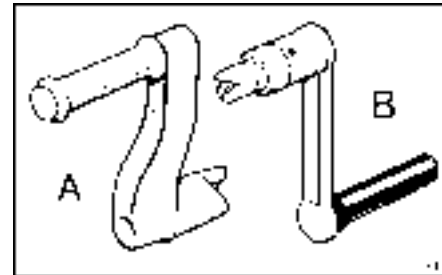

Figure 2.2.1 Starting Handles

- The two types of handle are not interchangeable and care must be taken to ensure the correct type is retained with the engine.
- Always use the correct starting handle which has been designed for the engine.
- Ensure there are no burrs on that part of the handle which fits onto the engine.
- Ensure the handle grip is clean, dry and free to turn on its shaft.
- Clean and lightly oil that part of the handle which fits onto the engine.
- Firmly hold the handle grip, **with the thumb on top of the grip**, during the starting procedure.

WARNING

Do not attempt to use a handle if it is damaged in any way.

2. Operating Instructions

- cold start aid and hand starting

2.3 Cold Starting Aid

An optional cold starting aid may be fitted to the combustion air intake port for use when the ambient temperature is below -10°C (14°F).

CAUTION

The device must not be used more than three times in succession during the same attempt to start the engine.

1. With the fuel turned on turn the engine for up to 20 revolutions to prime the fuel and lubrication systems.
2. Withdraw the plunger (A) and fill one third of the cup (B) with the same type of lubricating oil as used in the engine.

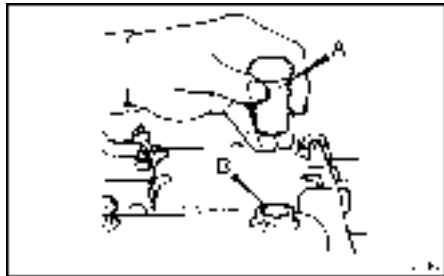

Figure 2.3.1 Cold Start

3. Replace the plunger and inject the oil just before starting the engine.

2.4 Hand Starting

Before attempting to start the engine refer to "2.2 Starting Handle Precautions".

1. Select the excess fuel position by gently pulling the engine control lever (A) outward over the middle catch (B) and turning it fully clockwise.

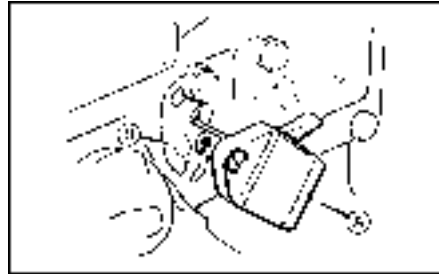

Figure 2.4.1 Engine Control

2. If a variable speed control lever is fitted move it to the fast position.
3. Move the decompressor lever towards the flywheel.

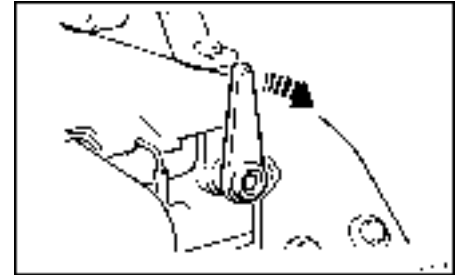

Figure 2.4.2 Decompressor Lever

4. If the ambient temperature is below -10°C (14°F) refer to "2.3 The Cold Starting Aid".

5a. If using a non-limited kick-back handle:

Insert the correct handle, refer to 'A' in 'Figure 2.2.1 Starting Handles', into the starting housing.

Slowly rotate the handle in the direction of cranking until it fully engages.

5b. If using a limited kick-back handle:

Swivel the starting handle housing cover (C) to one side, lift the spring loaded plunger (D), if fitted, and insert the correct handle, refer to 'B' in 'Figure 2.2.1 Starting Handles', into the housing.

Slowly rotate the handle in the direction of cranking until it fully engages.

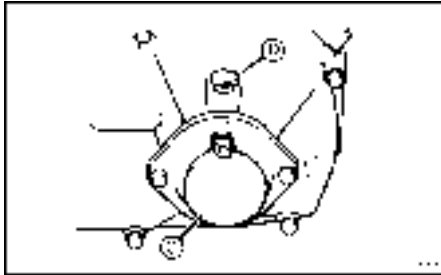

Figure 2.4.3 Starting Handle Housing

6. If the cold starting aid was not used turn the engine slowly for up to 20 turns to prime the combustion chamber and lubricating oil system.
7. Firmly hold the handle grip, with the thumb on top of the grip as shown in 'Figure 2.4.4 Holding the Starting Handle', and crank the engine really fast, when sufficient speed is obtained move the decompressor lever towards the gear end and continue to crank until the engine fires.

WARNING

Do not pull the starting handle away from the engine while cranking.

Retaining a firm grip on the handle, lift the spring loaded plunger (D), if fitted, and remove the handle from the housing.

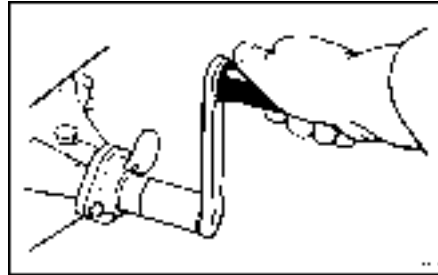

Figure 2.4.4 Holding the Starting Handle

8. Turn the engine control lever anti-clockwise to the 'RUN' position.
9. If a variable speed control is fitted reduce the speed as required.

2.5 Electric Starting

If the engine fails to start within 30 seconds, release the start key, or start button, and attempt to restart after allowing sufficient time for all moving parts to stop.

1. Select the excess fuel position by gently pulling the engine control lever (A) outward over the middle catch (B) and turning it fully clockwise.

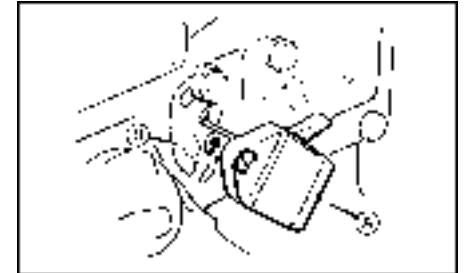

Figure 2.5.1 Engine Control

2. Check that the decompressor lever is towards the gear end.
3. If a variable speed control lever is fitted move it to the fast position.
4. If the ambient temperature is below -10°C (14°F) refer to items 2. and 3. in "2.3 Cold Starting Aid".

2. Operating Instructions

- stopping the engine

5. If a start key is being used:

Turn the start key clockwise and hold it at position '3', until the engine fires and then release it immediately.



Figure 2.5.2 Start Key

If a starter button is being used:

Press the starter button until the engine fires and then release it immediately.

6. Turn the engine control lever anti-clockwise to the 'RUN' position.
7. If a variable speed control is fitted reduce the speed as required.

2.6 Stopping the Engine

Turn the engine control fully anti-clockwise to the 'STOP' position and hold it there until the engine comes to rest.

After the engine has stopped ensure the start key, if fitted, is turned anti-clockwise to the 'OFF' position.



Figure 2.6.1 Engine Control

CAUTION

Turning the keyswitch to the 'OFF' position will not stop the engine.

CAUTION

Never stop the engine by operating the decompressor lever or valve damage may occur.

3. Engine Fluids

3.1 Oil Specification

To help assist engine running-in, all engines are despatched with an initial fill lubricating oil which must be changed after 100 hours.

All subsequent oil changes must be as specified in "4.13 Maintenance - schedule hours".

CAUTION

Some of the following classifications may not be available in your country. In cases of difficulty, it is suggested contact be made with a reputable oil supplier or any Lister Petter Distributor.

1. The temperatures mentioned in the tables are the ambient temperatures at the time when the engine is started. However, if monograde oils are used and running ambient temperatures are significantly higher than starting temperatures, a higher viscosity oil should be selected subject to satisfactory starting performance. Multigrade oils may be used to overcome the problem.

2. Where it is not practical to continually change oils to suit varying ambient temperatures, a suitable multigrade oil is recommended to ensure adequate starting performance at the lowest temperature likely to be encountered.
3. 'L' Series engines must be run on heavy duty lubricating oils that at least meet the requirements of one of the following:

API CC	MIL-L-46152B
DEF2101D	MIL-L-2104B

Straight mineral oils are not suitable, neither are oils of less detergency than specified.

Note:

Higher specification oils meeting API CD, API CE and API CF-4 are more commonly available than API CC. The use of these oils in new engines is acceptable for topping up the 'first fill' and following the first 100 hours when running-in has been completed.

These oils are particularly suited to engines running at a high load factor, or in conjunction with high ambient temperatures. They must also be used where the sulphur content of the fuel exceeds 0.5%.

CAUTION

API CD, API CE, API CF-4 or MIL-L-2104C/D/E oils can inhibit the running-in process in new or reconditioned engines and are not suitable for engines running on low duty cycles.

4. The oil must be suitable for 250 hour oil changes without undue degradation, with sump temperatures reaching 150°C (302°F) under severe tropical conditions, and 120°C (248°F) under normal conditions.
5. For engines in long running installations Lister Petter should be consulted.

3. Engine Fluids

- oil viscosity and fuel specification

3.3 Oil Viscosity

The following chart shows the correct oil viscosity for various °C ambient temperature ranges for cold start to maximum running temperatures.

Before selecting a viscosity grade refer to Notes:



Notes:

A. Intermittent running.

B. Synthetic oils only.

$$^{\circ}\text{F} = (1.8 \times ^{\circ}\text{C}) + 32.$$

- SAE 5W-20 oils are recommended on the basis that they are fully synthetic, and are technically suitable for use up to 25°C (77°F). Non synthetic oils at very low temperatures will suffer from wax crystallisation. Monograde SAE 5W is not normally available as a synthetic oil and therefore is not quoted.

- In order to maintain the cold starting characteristics of any recommended grade, it is essential that oil changes are made within the Lister-Petter recommendations.

An oil change is recommended immediately if the engine fails to reach its normal cold start cranking speed due to excessive oil viscosity.

Fuel dilution of the lubricating oil will adversely affect cold starting and oil consumption.

- SAE 30 and 10W-30 oils may be used at up to 52°C (126°F) but oil consumption may be affected. 10W-40, 15W-40 and 20W-40 multigrade oils are recommended for continuous full load operation at this temperature.
- Monograde SAE 40 oils are not recommended.

3.4 Fuel Specification

The engine must only be used with diesel fuel oil which conforms to one of the following:-

- BS 2869:1988 Class A2.
- BS EN590:1995 Class A1.
- USA Specification ASTM D-975-77 Grades No.1-D and 2-D.
- BSMA 100 Class M1 for marine use.

The fuel must be a distillate, and not

a residual oil or blend. Vaporising oils are not suitable as fuels for these diesel engines.

The user is cautioned that although the engines may operate on fuels outside the above specifications, such operation may well result in excessive wear and damage.

CAUTION

The fuel injection equipment is manufactured to very accurate limits and the smallest particle of dirt will destroy its efficiency.

Fuel, free from water and contaminants is of the utmost importance.

3.5 Fuel in Low Temperatures

Special winter fuels are often available for use at ambient temperatures below 0°C (32°F).

These fuels have a lower viscosity and limit the formation of wax at low ambient temperatures.

CAUTION

Wax formation can rapidly reduce the flow of fuel through the fuel filter element.

4. Engine Servicing

4.1 Preliminary Instructions

These recommendations and instructions cover LT and LV engines therefore they are of a general nature and may include optional equipment not specifically covered in this book.

More detailed information can be found in the Workshop Manual or any Lister Petter Diesel distributor can be consulted.

- The engine should receive regular attention during the first 50 hours of its life from new and after a major overhaul.
- Long periods of light or 'no load' running early in the engine's life may lead to cylinder bore glazing and high oil consumption.
- The instructions given in "4.13 Maintenance - schedule hours" are based on average operating conditions and cover the minimum requirements to keep an engine running at peak performance with trouble free operation.
- Under very dusty conditions, air cleaners, lubricating oil and fuel filters will require more frequent attention.
- Decarbonising may be required more often if the engine has been running on light loads for long periods.

- Before carrying out any maintenance work on an engine it is advisable to remove the battery.

The battery and charge windings must be disconnected before commencing any electric welding when a pole strap is directly or indirectly connected to the engine.

- It is essential to ensure that nuts and bolts are tightened to the torques specified in the Workshop Manual.
- When re-assembling an engine lubricate all moving parts with engine oil.
- Renew nuts and bolts that have been taken from high stress locations.

In particular nuts and/or bolts from the connecting rods should be renewed.

- The fuel injector can only be checked and set off the engine using suitable specialist test equipment.

WARNING

ON NO ACCOUNT ALLOW ANY UNPROTECTED SKIN TO COME INTO CONTACT WITH THE INJECTOR SPRAY AS THE FUEL MAY ENTER THE BLOOD STREAM WITH FATAL RESULTS.

WARNING

SOME ENGINES MAY BE FITTED WITH SEALS OR 'O' RINGS MANUFACTURED FROM 'VITON' OR A SIMILAR MATERIAL. WHEN EXPOSED TO ABNORMALLY HIGH TEMPERATURES, IN EXCESS OF 400°C (752°F), AN EXTREMELY CORROSIVE ACID IS PRODUCED WHICH CANNOT BE REMOVED FROM THE SKIN.

IF SIGNS OF DECOMPOSITION ARE EVIDENT, OR IF IN DOUBT, ALWAYS WEAR DISPOSABLE HEAVY DUTY GLOVES.

4.1.1 Before Starting Work

Before starting any dismantling procedure the following should be considered:

- Do you know and understand the engine and all the related systems?
- Do you have sufficient electrical and mechanical knowledge and skills to understand the symptoms?
- Do you have suitable electrical diagnostic equipment available?
- Do you have, or access to, the necessary Lister Petter spare parts before you commence dismantling.

4. Engine Servicing

- precautions, initial attention and priming

4.2 Precautions for Filters and Elements

- Particular attention is drawn to the instructions given later in this section for replacing filters.
- Used liquid filters and elements contain some of the filtered liquid and should be handled and disposed of with care.
- After handling new or used elements the users hands should be thoroughly washed, particularly before eating.

WARNING

Fuel and new or used lubricating oil may cause skin irritation.

WARNING

The materials used in the manufacture and treatment of some filters and elements may cause irritation or discomfort if they come into contact with the eyes or mouth and they may give off toxic gases if they are burnt.

WARNING

Care must be taken to ensure that waste fuel, oil and filter elements are disposed of in accordance with local regulations to prevent contamination.

4.3 Initial Attention

To help assist engine running-in, all engines are despatched with an initial fill lubricating oil which must be changed after 100 hours.

All subsequent oil changes must be as specified in "4.13 Maintenance - schedule hours".

It is recommended that the following receive attention after the engine has run 50 hours and again after 250 hours.

- Adjust the valve clearances, if necessary.
- Check and tighten nuts, bolts and unions paying particular attention to the fuel system.
- Check the lubricating oil level and top up if necessary.
- Observe the exhaust at the normal full load.

The exhaust must be free from soot. A black exhaust means that the engine is overloaded or that the injection equipment is out of order.

Do not allow the engine to run with a dirty exhaust without investigating the cause as this may result in an expensive breakdown.

- Following the initial attention, routine maintenance must be carried out as specified in "4.13 Maintenance - schedule hours".

4.4 Priming the Fuel System

If the engine is fitted with a self priming fuel system it should not be necessary to prime the system.

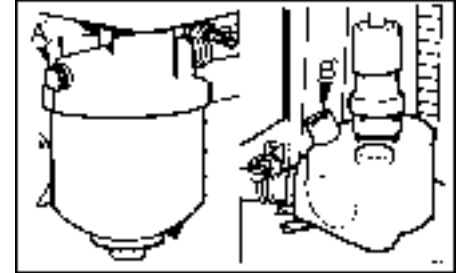

Figure 4.4.1 Priming the Fuel System

1. Fill the fuel tank.
2. Move the engine control lever to the 'RUN' position.
3. Vent the fuel filter through the bleed screw (A) until a full air free flow of fuel is obtained.
4. Vent fuel at the pump through the bleed screw (B) until a full air free flow of fuel is obtained.

4.5 Valve Clearance Adjustment

The valve clearance for both inlet and exhaust valves must be set with the engine cold.

1. Remove the cylinder head cover.
2. Ensure the cylinder head nuts are correctly tightened.
3. Turn the flywheel until the piston is at the TDC position on the firing stroke; TDC is marked on the flywheel.
4. Slacken the locknut (A) and adjust the screw (B) until the correct clearance has been obtained.
GO - 0.10mm (0.004in).
NOT GO - 0.15mm (0.006in).

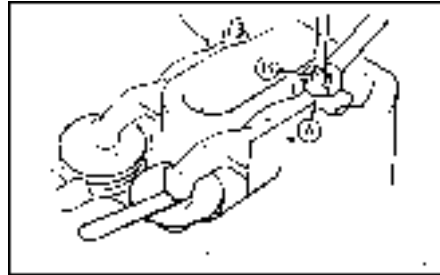

Figure 4.5.1 Setting the Valve Clearance

5. Tighten the locknut whilst restraining the adjusting screw and re-check to ensure the clearance is correct.
6. Repeat for the remaining valve.
7. Replace the rocker cover taking care to ensure the decompressor lever is vertical.

4.6 Decompressor Adjustment

This adjustment should only be made when the valve clearance is correctly adjusted.

1. Remove the cylinder head cover.
2. Turn the flywheel until the piston is at the TDC position on the firing stroke; TDC is marked on the flywheel.
3. Adjust the screw (A) until the exhaust valve just begins to move downwards when the lever is vertical.
4. Turn the screw a further turn clockwise so that it travels towards the rocker.

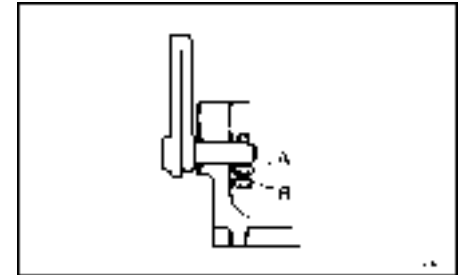

Figure 4.6.1 Decompressor Adjustment

5. Replace the rocker cover taking care to ensure the decompressor lever is vertical.

4. Engine Servicing

- air cleaner

4.7 Air Cleaner - Build 32

1. Slacken the clip (A).
2. Remove the cleaner (B) from the manifold (C).

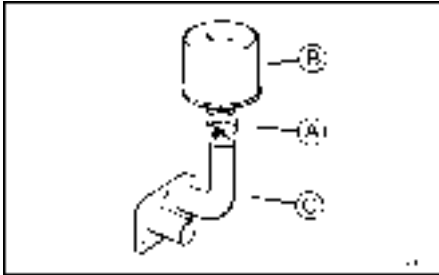

Figure 4.7.1 Air Cleaner - Build 32

3. Fit a new cleaner assembly.

4.8 Air Cleaner - electric start Builds

1. Remove the air cleaner from the manifold by removing the centre bolt (A) taking care to retain the copper washer.

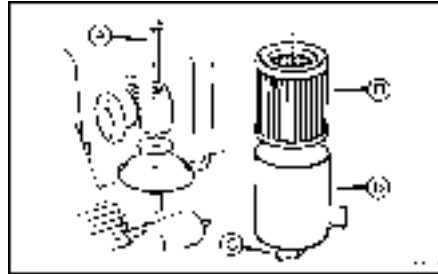

Figure 4.8.1 Air Cleaner

2. Remove the cover (B) by unscrewing the centre bolt (C).
3. Remove the old element (D) and fit a new one.

4.9 Air Cleaner - other Builds

1. Remove the cover (A) by removing the centre bolt.

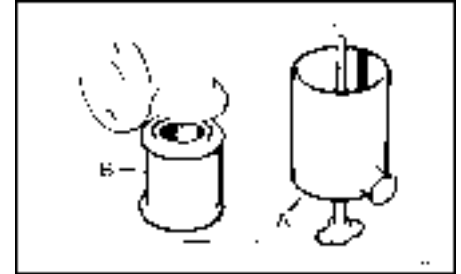

Figure 4.9.1 Air Cleaner

2. Remove the old element (B) and fit a new one.

4.10 Draining and Filling the Oil Sump

Before draining the oil read, "4.2 Precautions for Filters and Elements".

CAUTION

Do not overfill with lubricating oil as this may have a detrimental effect on engine performance.

1. If possible run the engine immediately before draining the oil.
2. Place a suitable container under the drain plug.
3. Remove the drain plug (A).

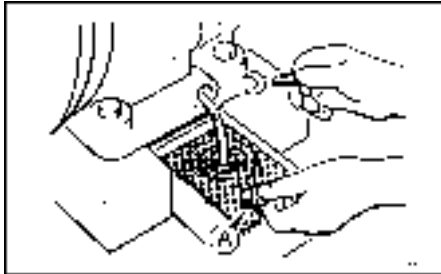

Figure 4.10.1 Oil Drain

4. Clean and coat the threads of the flanged drain plug with Wellseal and the tapered plug with Hylomar PL32/ M or Three Bond 1110B.
5. Replace the drain plug taking care not to over-tighten it.

6. Fill the sump through the oil filler to the top mark on the dipstick (B).

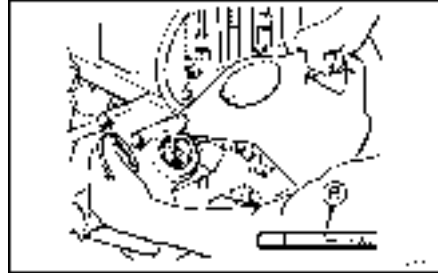

Figure 4.10.2 Oil Filler

7. Start the engine, run it for a few minutes and check the drain plug does not leak.
8. Stop the engine, allow the oil to settle and check the level on the dipstick.
9. Add more oil if necessary.

Oil Sump Capacity

	litres	pints	US qts
LT1	1.3	2.3	1.3
LV1	1.3	2.3	1.3

Capacity Between Dipstick Marks

	litres	pints	US qts
LT1	0.20	0.35	0.21
LV1	0.20	0.35	0.21

4. Engine Servicing

- fuel filter and battery

4.11 Changing the Fuel Filter

Before changing the filter, read "4.2 Precautions for Filters and Elements".

1. Remove the retaining bolt or plug (A).
2. Remove the old element (B) and joints (C).
3. Fit a new element and new joints.
4. Replace and tighten the retaining bolt or plug (A).
5. Prime the fuel system.

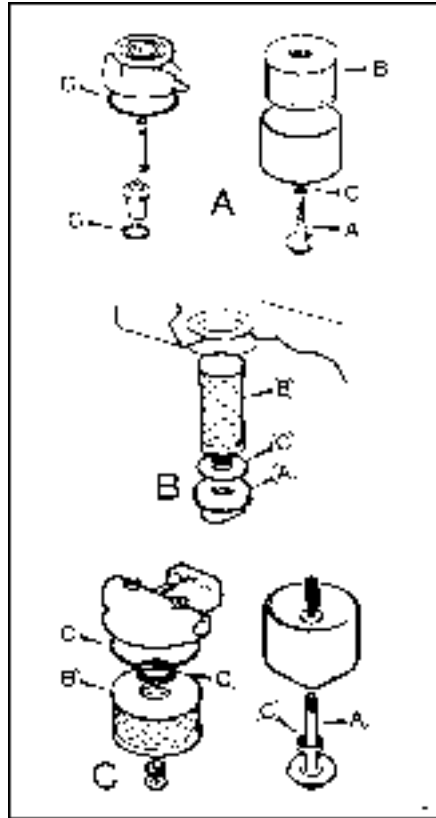

Figure 4.11.1 Fuel Filter Elements

4.12 Checking the Battery

1. Wear protective gloves and goggles.
2. Clean the top of the battery filler plug area.
3. Remove the filler plugs and check that the electrolyte level is 6.0-9.0mm (0.25-0.37in) above the tops of the separators.
4. If necessary top up with distilled water.
In cold weather distilled water should only be added immediately before running the engine.
5. Replace and tighten the filler plugs.
6. Check that the terminal connections are tight; petroleum jelly will help to protect them from corrosion.

WARNING

BATTERIES CONTAIN SULPHURIC ACID WHICH CAN CAUSE SEVERE BURNS AND PRODUCE EXPLOSIVE GASES. IF THE ACID HAS BEEN SPLASHED ON THE SKIN, EYES OR CLOTHES FLUSH WITH COPIOUS AMOUNTS OF FRESH WATER AND SEEK IMMEDIATE MEDICAL AID.

4.13 Maintenance - schedule hours

To help assist engine running-in, all engines are despatched with an initial fill lubricating oil which must be changed after 100 hours.

All subsequent oil changes must be as specified below.

Daily
Check the fuel and lubricating oil levels.
Check for oil and fuel leaks.
Clean, or replace, the air cleaner element under very dusty conditions.

Every 125 Hours

The above and the following items.
Check the condition of the battery, if fitted.
Clean or replace the air cleaner element under moderately dusty conditions.

Every 250 Hours

The above and the following items.
Drain the sump and refill with new oil of the correct type and specification as given in "3.1 Oil Specification".
Clean or replace the injectors if the exhaust is dirty.
Renew the fuel filter element if the fuel being used is not perfectly clean.

Every 500 Hours
The above and the following items.
Replace the air cleaner element.
Examine the exhaust and induction systems for leaks, damage or restrictions.
Renew the fuel filter element.
Check the battery charge winding system; refer to the Workshop Manual.

Every 1000 Hours

The above and the following items.
Check the valve clearances.
Decarbonise if the engine performance has deteriorated.
Clean the cylinder barrel and head fins.
Clean the banjo union at the cylinder head end of the oil feed pipe.

Every 2000 Hours

The above and drain, flush and refill the fuel tank.
--

4.14 Troubleshooting

Troubleshooting mechanical engine problems can be difficult. This section lists possible engine problems that could be encountered with possible causes. The information given is of a general nature as it covers the basic engine and your particular application may be different.

If you are in any doubt, contact your local Lister Petter distributor.

Before starting any dismantling procedure the following should be considered:

- a. Do you know and understand the engine and all the related systems?
- b. Do you have sufficient electrical and mechanical skills and knowledge to understand the symptoms?
- c. Do you have suitable electrical diagnostic equipment available?
- d. Do you have, or access to, the necessary Lister Petter spare parts before you commence dismantling.

4. Engine Servicing

- troubleshooting

Method of Troubleshooting

1. Diagnose the problem by eliminating the easiest things first.
2. Before starting to remove or dismantle any components double check your observations.
3. When electrical troubleshooting always start at the battery first.

Difficult Starting
Stop/start lever in the wrong position.
Decompressor lever in the wrong position.
Incorrect type of fuel or oil.
No fuel in the tank.
Choked fuel filter or air cleaner.
Air lock in the fuel system.
Incorrect decompressor clearance.
Battery not serviceable.
Loose electrical connection.
Load not disconnected.
Turning the crankshaft the wrong way.

Engine Stops
Lack of fuel.
Air in the fuel system.
Choked fuel filter.
Excessive overload.
Overheating.
Loss of compression.
Loss of oil.

Loss of Power
Incorrect tappet clearance.
Choked air cleaner or fuel filter.
Choked exhaust system.

Failure to Attain Normal Speed
Engine started on overload.
Fuel system not correctly primed.
Insufficient fuel.

Knocking
Loose coupling or pulley.
Engine loose on its mounting.
Incorrect specification of fuel.

Exhaust Smoke
White smoke - generally as a result of water in the fuel.
Faint blue smoke - appears with light load.
Heavy blue smoke - caused by lubricating oil passing the piston rings due to stuck, worn or broken rings or a worn cylinder.
Black smoke due to incomplete combustion of the fuel can be caused by overload, choked air filter, inlet air temperature too high or incorrect specification of fuel.

Overheating
Air inlet obstructed.
Overload
Lubricating oil level too low.

Hunting
Air in the fuel system.

4.15 Long Term Storage

The following routine should be carried out when it is known that the engine will not be required for some months.

If the procedure is not carried out the engine should be run on full load for approximately 45 minutes once a month.

CAUTION

As a direct result of combustion, the lubricating oil may contain harmful acids. It should not be left in the sump if it is known that the engine will not be used for extended periods.

Preparing the Engine for Storage

- a. Replace the fuel in the tank with a small supply of suitable inhibition fluid.
- b. Drain the lubricating oil from the sump and refill with new oil.
- c. Run the engine for a period to circulate the oil through the system and to ensure the inhibition fluid is passed through the fuel pumps and injectors.
- d. Stop the engine and drain the lubricating oil from the sump.

The crankshaft should NOT be turned until the engine is again required for service.

The inhibition fluid should be left in the fuel system.

- e. Seal all openings on the engine with tape.
- f. Remove the batteries and store them fully charged after coating the terminals with petroleum jelly.
- g. Grease all external bright metal parts and the speed control linkage.
- h. Tie labels on the engine clearly stating what steps have been taken to inhibit the engine during storage.

Returning the Engine to Service

Refer to the appropriate sections for the relevant detailed instructions as necessary to complete this work.

- a. Remove the tie-on labels and all the protective coverings from openings and apertures.
- b. Fill the fuel tank.
- c. Refill the lubricating oil sump with new oil of the correct specification and viscosity.
- d. Remove the batteries from store. If they are still fully charged reconnect them to the engine.
Coat the terminals with petroleum jelly.
- e. Start the engine and check for fuel and oil leaks before applying load.

5. Index

A	H	P
Air cleaner 16	Hand starting 8	Priming the fuel system 14
Ambient temperature 7		
Associated publications 2	I	R
	Initial attention 14	Running-in 2
	Introduction 2	
B	L	S
Battery 18	Long term storage 21	Safety precautions 4, 5, 7, 14
		Safety symbols 5
C	M	Serial number 6
Cold starting aid 8	Maintenance - schedule hours 19	Stopping the engine 10
	N	
D	Nomenclature 6	T
Decompressor adjustment 15		Technical data 6
	O	U
E	Oil specification 11	Using this Operators Handbook 2
Electric starting 9	Oil sump 17	
Engine features 3	Oil viscosity 12	V
	Operating instructions 7	Valve clearance 15
F		
Fault diagnosis 19		
Fuel filter 18		
Fuel for low temperatures 12		
Fuel specification 12		

CALIFORNIA

Proposition 65 Warning

Engine exhaust and some of its constituents are known to the State of California to cause cancer, birth defects, and other reproductive harm.

Publication P027-08186 Edition 10

© 2003 Copyright Lister Petter UK Limited, all rights reserved

Published in April 2003 by Lister Petter

Printed in the United Kingdom

Lister Petter UK Limited, Dursley GL11 4HS, England